



# РУКОВОДСТВО ПО УСТАНОВКЕ

Stage1 621





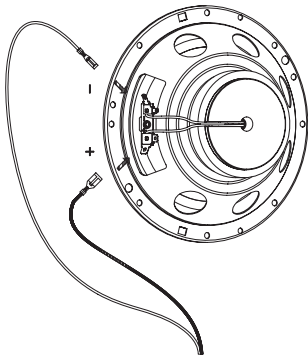
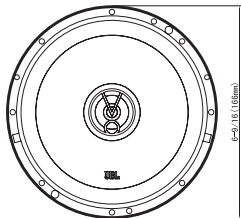
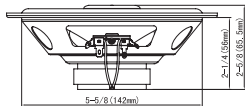

Stage1 9631

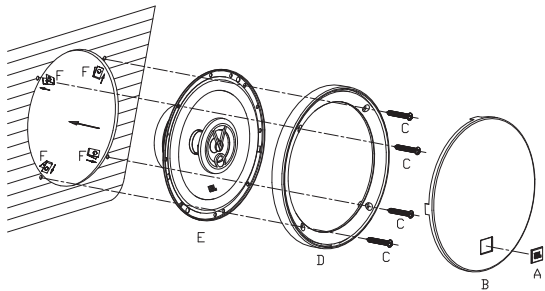
Stage1 601C

# Stage1 621





<p>A</p>  <p>2x</p>	<p>B</p>  <p>2x</p>	<p>C</p>  <p>8x</p>	<p>D</p>  <p>2x</p>	<p>E</p>  <p>2x</p>	<p>F</p>  <p>8x</p>
------------------------------------------------------------------------------------------------------	------------------------------------------------------------------------------------------------------	------------------------------------------------------------------------------------------------------	------------------------------------------------------------------------------------------------------	--------------------------------------------------------------------------------------------------------	--------------------------------------------------------------------------------------------------------

## Технические Характеристики

- Тип: 160 мм двухполосная акустическая система для автомобиля
- Предельная шумовая мощность: 35 Вт (среднеквадратическая), 175 Вт (пиковая)
- Чувствительность (2,83 В/м): 90 дБ
- Частотная характеристика: 55 Гц – 20 кГц
- Номинальный импеданс: 4 Ом



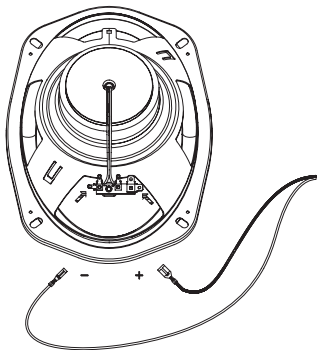
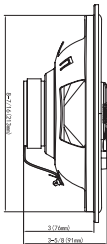
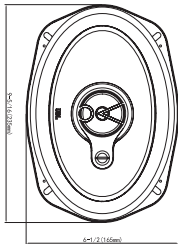
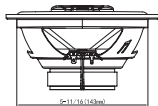

## Параметры Тила-Смолла

- BL (Tm): 2.408
- DCR (ohm): 3.2
- Mms (g): 8.552
- Sd (cm<sup>2</sup>): 128.68
- Cms (µm/N): 411.426
- Vas (l): 9.674
- Fs (Hz): 85
- Qes: 2.515
- Qms: 3.616
- Qts: 1.483
- Crossover Point: 4.2 kHz

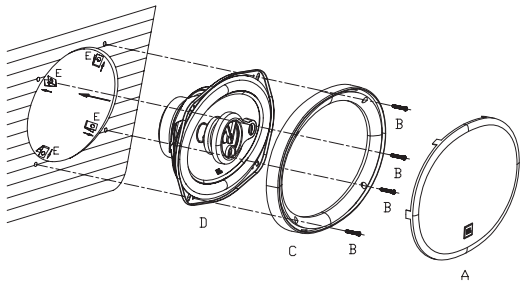
# Stage1 9631





<p>A</p>  <p>2x</p>	<p>B</p>  <p>8x</p>	<p>C</p>  <p>2x</p>	<p>D</p>  <p>2x</p>	<p>E</p>  <p>8x</p>
------------------------------------------------------------------------------------------------------	------------------------------------------------------------------------------------------------------	------------------------------------------------------------------------------------------------------	-------------------------------------------------------------------------------------------------------	--------------------------------------------------------------------------------------------------------

## Технические Характеристики

- Тип: 152 x 230 мм трехполосная акустическая система для автомобиля
- Предельная шумовая мощность: 60 Вт (среднеквадратическая), 300 Вт (пиковая)
- Чувствительность (2,83 В/м): 89 дБ
- Частотная характеристика: 50 Гц – 21 кГц
- Номинальный импеданс: 4 Ом

## Параметры Тила-Смолла

- BL (Tm): 3.192
- DCR (ohm): 2.3
- Mms (g): 17.316
- Sd (cm<sup>2</sup>): 213.565
- Cms (µm/N): 311.651
- Vas (l): 20.184
- Fs (Hz): 70
- Qes: 1.683
- Qms: 3.878
- Qts: 1.174
- Crossover Point: 3.8 kHz



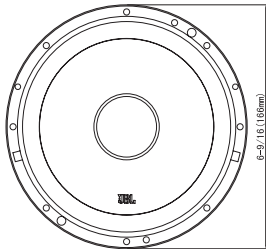
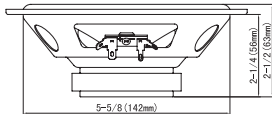

# Stage1 601C

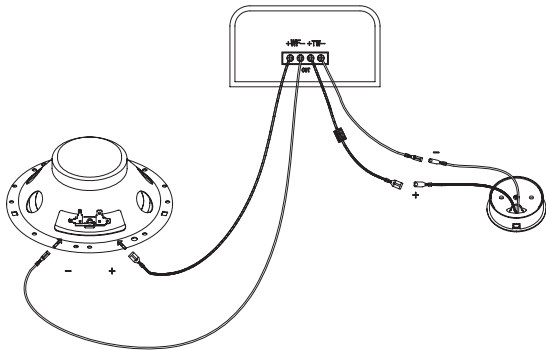

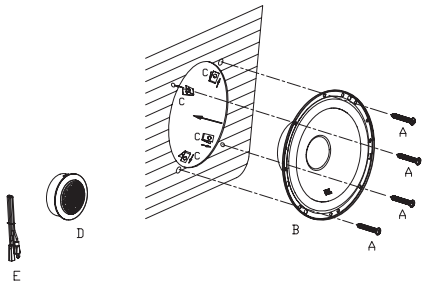





<p>A</p>  <p>8x</p>	<p>B</p>  <p>2x</p>	<p>C</p>  <p>8x</p>	<p>D</p>  <p>2x</p>	<p>E</p>  <p>2x</p>
------------------------------------------------------------------------------------------------------	------------------------------------------------------------------------------------------------------	------------------------------------------------------------------------------------------------------	-------------------------------------------------------------------------------------------------------	--------------------------------------------------------------------------------------------------------

## Технические Характеристики

- Тип: 160 мм двухполосная компонентная акустическая система для автомобиля
- Предельная шумовая мощность: 40 Вт (среднеквадратическая), 200 Вт (пиковая)
- Чувствительность (2,83 В/м): 90 дБ
- Частотная характеристика: 55 Гц – 20 кГц
- Номинальный импеданс: 4 Ом

## Параметры Тила-Смолла

- BL (Tm): 3.588
- DCR (ohm): 3.2
- Mms (g): 11.01
- Sd (cm<sup>2</sup>): 128.68
- Cms (µm/N): 348.261
- Vas (l): 8.189
- Fs (Hz): 85
- Qes: 1.398
- Qms: 3.618
- Qts: 1.008
- Crossover Point: 6.0 kHz



HARMAN International Industries,  
Incorporated  
8500 Balboa Boulevard, Northridge,  
CA 91329 USA (США)  
© 2019 HARMAN International  
Industries, Incorporated.

Все права защищены.

JBL является товарным знаком компании HARMAN International Industries, Incorporated, зарегистрированным в США и/или других странах.

Функции, характеристики и внешний вид могут изменяться без уведомления.